

Track Linear Pendant

TRL29433
INSTALLATION SHEET

START FROM HERE

- Make sure **POWER** is **COMPLETELY OFF** at the fuse box
- Have your fixture installed by a qualified licensed electrician
- Prepare everything in a clear area
- Wear gloves at all times during this installation
- Read instructions carefully before you start assembly
- Keep this installation sheet for future reference

Technical Support: 1-855-855-8926

Please Note:

- This Kuzco LED fixture comes with pre-wired LED module(s)
- Unless instructed, Do Not touch any part of the LED module(s) as any unnecessary contact with the module could cause permanent damage
- For use with 48V DC Class 2 LED drivers only (see available canopy/driver options)

- 1.** Once track (**TRT989100/TRT989200, sold separately**) is mounted on mounting surface, proceed with removing fixture from its original package
- 2.** Separate track adaptor (**1a**) from track adaptor chassis (**2a**) by removing the screws (**1b**)
- 3.** To change fixture height, shorten or lengthen wire by removing screw (**2c**) from track adaptor chassis (**2a**). Release the wire strain relief (**2b**) in centre of track adaptor chassis (**2a**) and push or pull wire to desired length. Tighten the wire strain relief in the center of the track adaptor chassis (**2a**). Slide the wire strain relief (**2b**) down the wire until it is as close as possible to where the wire enters the inside of the track adaptor chassis (**2a**) (**See Illustration 2**) and secure screw (**2c**) in track adaptor chassis (**2a**) (**See Illustration 1**) to lock the wire in place
- 4.** Make low voltage wire connection by connecting fixture wire to 48V low voltage input wire with wire connectors (**3a**) provided in hardware package
- 5.** Attach track adaptor (**1a**) to track adaptor chassis (**2a**) and secure with screws (**1b**)
- 6.** Attach fixture to track (**Sold Separately**) using track adaptor assembly (**1a/2a**), followed by track covers (**Sold with Track Component**). Cut track covers to desired length

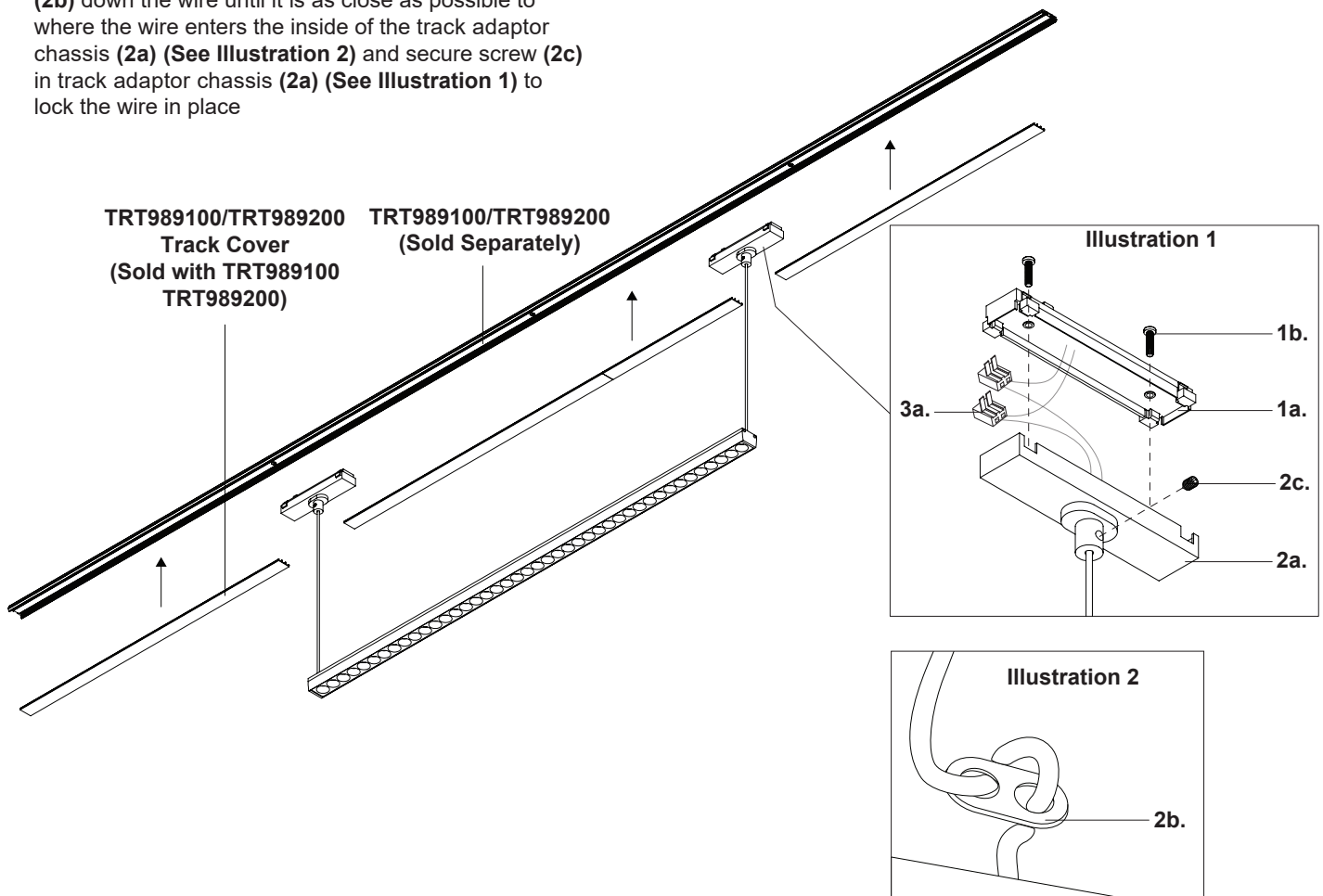

KUZCO

19054 28th Avenue Surrey, BC Canada V3Z 6M3
T: 604 538 7162 TF: 1-855 85 KUZCO F: 604 538 7196
W: kuzcolighting.com
20240903